

# UNIT THREE

## PLACES 1: COUNTRIES, CITIES, TOWNS and VILLAGES

### READING

1 Fatima is writing about a town in Oman. Underline the verbs.

Birka is a small town in the north of Oman. It is situated on the coast. It has a population of about 10,000 people. Birka is famous for fishing and for dates. The town is surrounded by date palms. It also has an old fort and there is a small market near the beach.

- a) How many sentences are there? \_\_\_\_\_
- b) How many full stops? \_\_\_\_\_
- c) There are two verbs used in the paragraph. What are they? \_\_\_\_\_ and \_\_\_\_\_

Remember! We use capital letters for the names of towns, cities, villages and for countries.

d) What is the name of the town?

The name \_\_\_\_\_

e) Where is it?

It is \_\_\_\_\_

2 Read about this village.

Misfah is a small village in the centre of Oman. It has a population of only a few hundred people. It is famous for its dates, lemons and limes. It is a beautiful place. There is fresh water and there are many trees. The village is surrounded by mountains.

There are three verbs. What are they? \_\_\_\_\_, \_\_\_\_\_ and \_\_\_\_\_

Now complete the table.

Name	Birka	Misfah
City/town/village	town	_____
Situated	north coast	_____
Country	Oman	_____
Population	10,000	_____
Famous for	fishing and dates	_____

3 Ali is writing about towns, cities and villages in Bahrain. Put the names on the map.

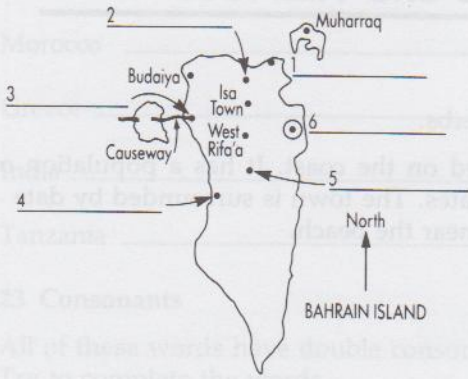

The capital of Bahrain is *Manama*. It is situated on the north coast of Bahrain Island. *Jidhafs* and *Isa Town* are also situated in the north. In the centre of the island are the towns of *West Rifa'a* and *Awali*. *Awali* is an oil town. On the west coast near the causeway are the villages of *Jasra* and *Budaiya*. Also on the west coast, south of *Jasra*, is the fishing village of *Zallaq*. On the east coast is the industrial area of *Sitra* and north of *Sitra* is the island of *Muharraq*. In the south of Bahrain Island there are only a few very small villages. Most people live in the north of the island.

4 Manama is the capital city of Bahrain. Here are some other capital cities. Write them next to their countries.

Damascus	Manama	Paris	Washington	London	Riyadh	Algiers	Moscow
Cairo	Amman	Delhi	Karachi	Muscat	Doha	Abu Dhabi	Nicosia
Baghdad	Colombo	Tokyo	Beirut	Ankara	Athens		

Bahrain	_____	Syria	_____
Iraq	_____	Jordan	_____
Egypt	_____	Algeria	_____
Lebanon	_____	Oman	_____
Japan	_____	Pakistan	_____
Turkey	_____	India	_____
France	_____	Saudi Arabia	_____
Qatar	_____	Sri Lanka	_____
Greece	_____	Cyprus	_____

Note: These countries begin with **the**:

The United Arab Emirates (the UAE) \_\_\_\_\_

The United States of America (the USA) \_\_\_\_\_

The United Kingdom (the UK) \_\_\_\_\_

The Union of Soviet Socialist Republics  
(the USSR *or* Russia) \_\_\_\_\_

5

a) Which country do you live in? \_\_\_\_\_

b) Do you live in a city, a town or a village? \_\_\_\_\_

c) What is its name? \_\_\_\_\_

6 Add some cities, towns and villages to the lists.

*cities*

*towns*

*villages*

Cairo

Birka

Misfa

_____	_____	_____
_____	_____	_____
_____	_____	_____
_____	_____	_____
_____	_____	_____

7 Read the paragraph about Birka on page 31 again and complete this sentence:

Birka has an \_\_\_\_\_ and a small \_\_\_\_\_.

Here are some more of the important or interesting places in towns and cities.

a castle

a park

a zoo

a museum

a harbour

a beach

an airport

a factory

a corniche

a mosque

a square

an embassy

a river

Which of these are there in your town/village/city?

\_\_\_\_\_

What other interesting places are there? \_\_\_\_\_

**Language: There is/There are**

When we write about a place we write sentences such as:

THERE	VERB	WHAT?	WHERE?
There	is	a small market	in Birka.
There	are	many trees	in Misfah.

8 Write **There is** or **There are** in these sentences:

- a) \_\_\_\_\_ a new airport in Jeddah.
- b) \_\_\_\_\_ some beautiful mosques in Istanbul.
- c) \_\_\_\_\_ an old castle in Kerak.
- d) \_\_\_\_\_ many modern buildings in Amman.
- e) \_\_\_\_\_ a large harbour in Bombay.

■ **SENTENCE BUILDING**

9 Look at this table.

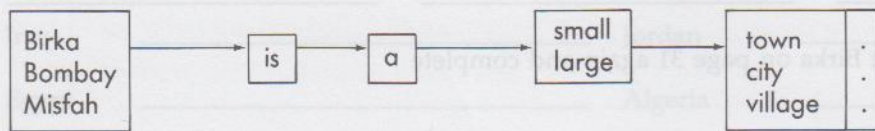

Write three sentences from the table.

- a) \_\_\_\_\_
- b) \_\_\_\_\_
- c) \_\_\_\_\_

Now write a sentence about your city/town/village.

- d) \_\_\_\_\_

10 Write five sentences with **There is** and **There are** using the pictures and the table.

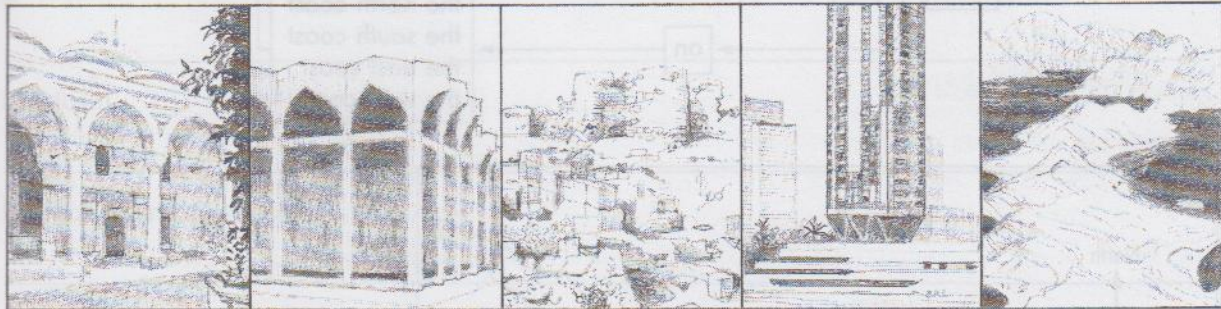
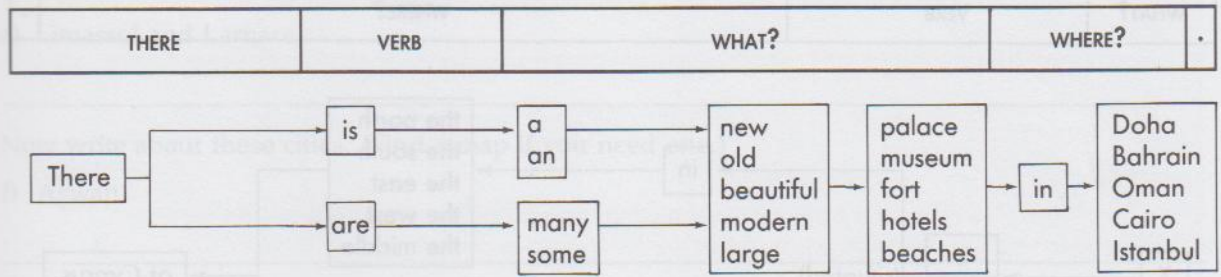

Istanbul

Doha

Bahrain

Cairo

Oman

- a) \_\_\_\_\_
- b) \_\_\_\_\_
- c) \_\_\_\_\_
- d) \_\_\_\_\_
- e) \_\_\_\_\_

Write two sentences about where you live.

- f) \_\_\_\_\_
- g) \_\_\_\_\_

Language: **WHERE? – in/on**

Notice we write:

Birka is in the north of Oman.	but: Birka is on the coast.
Misfah is in the centre.	and: Zallaq is on the west coast.

11 Look at the table and the map below.

WHAT?	VERB	WHERE?
-------	------	--------

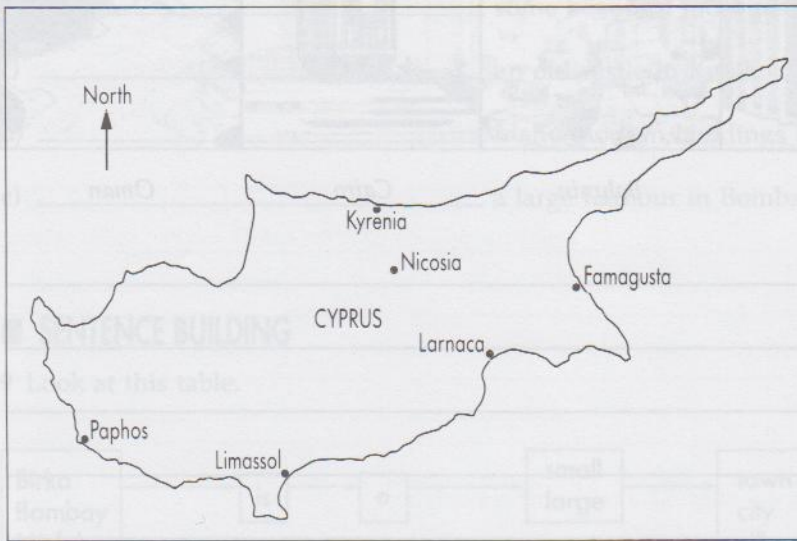
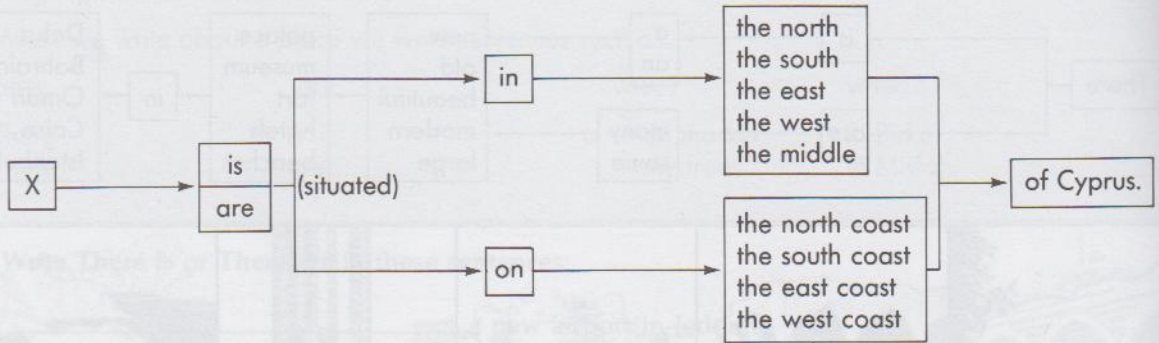

Now write sentences about these towns.

a) Paphos

---

b) Kyrenia

---

c) Nicosia

---

d) Famagusta

---

e) Limassol and Larnaca

---

Now write about these cities. (Find a map if you need one.)

f) Aswan

---

g) Riyadh

---

h) Mosul

---

i) your town/city/village

---

**Language: is not/are not**

We add **not** after **is** and **are** to make negatives.

For example:

Aleppo **is not** on the coast.

There **are not** many trees in my town.

We can also write: **isn't** and **aren't**.

12 Make negative sentences using the words in brackets.

a) Baghdad is situated on a river. (Doha)

---

b) There are many mountains in Yemen. (Bahrain)

---

c) Casablanca and Agadir are on the coast. (Marrakesh and Fez)

---

d) There is a camel market in Al Ain. (Dubai)

---

Language: **a** and **the**

When we know there is only one of a thing we say **the**. For example:

**the** capital of Bahrain  
**the** centre of the island  
**the** north coast  
**the** south  
 etc.

We also write **the** when we have already written about the thing or place. For example:  
 Birka is **a** small town in the north of Oman. **The** town is surrounded by date palms.

### ■ GUIDED PARAGRAPHS

13 Read about these two places in the country of Howar. (It is not real). Complete the paragraphs with **a**, **an** or **the**.

a) Tarbat is \_\_\_\_\_ small town in \_\_\_\_\_ south of \_\_\_\_\_ country. It is on \_\_\_\_\_ coast.

It has \_\_\_\_\_ population of about two thousand. It has \_\_\_\_\_ small market and \_\_\_\_\_ old fort in \_\_\_\_\_ centre of \_\_\_\_\_ town. It is famous for fishing and boat building.

b) Darseit is \_\_\_\_\_ small village in \_\_\_\_\_ north of \_\_\_\_\_ country. It is not on \_\_\_\_\_ coast. It is situated on \_\_\_\_\_ hill. Darseit is famous for its beautiful carpets. It has \_\_\_\_\_ population of five hundred people.

Now read about two more places. Put in the missing verbs: **is**, **are**, **has**.

c) Dukhan \_\_\_\_\_ a village on the west coast of the country. It \_\_\_\_\_ a population of four hundred people. It \_\_\_\_\_ a small harbour. There \_\_\_\_\_ many coconut palms around the village. Dukhan \_\_\_\_\_ not very famous, but it \_\_\_\_\_ a very beautiful place.

d) Daria \_\_\_\_\_ a small town in the north of the country. It \_\_\_\_\_ situated on a river. The town \_\_\_\_\_ surrounded by date palms. It \_\_\_\_\_ many modern buildings. There \_\_\_\_\_ some factories and there \_\_\_\_\_ an airport outside the town. Daria \_\_\_\_\_ a population of over twelve thousand people.



Read the paragraphs again and write the names by the pictures.

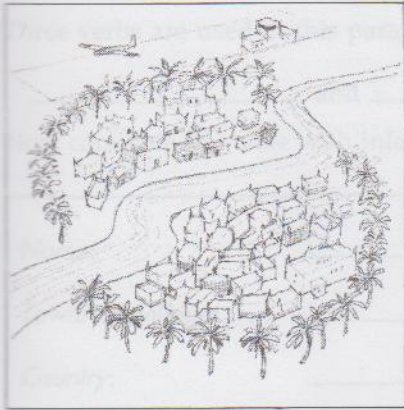

1. \_\_\_\_\_

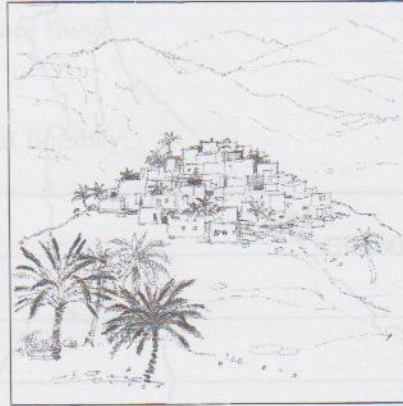

2. \_\_\_\_\_



3. \_\_\_\_\_

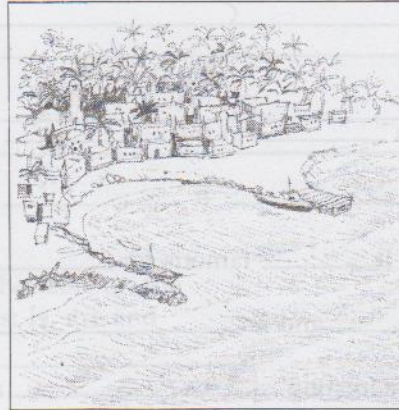

4. \_\_\_\_\_

14 Look at the table below and the map on the next page and complete the paragraph.

<b>Name:</b>	Al Ain
<b>Town/city/village:</b>	city
<b>Country:</b>	the UAE
<b>Situated:</b>	east
<b>Population:</b>	200,000
<b>Famous for:</b>	fresh water, trees
<b>Interesting places:</b>	zoo, entertainment park, museum, camel market.

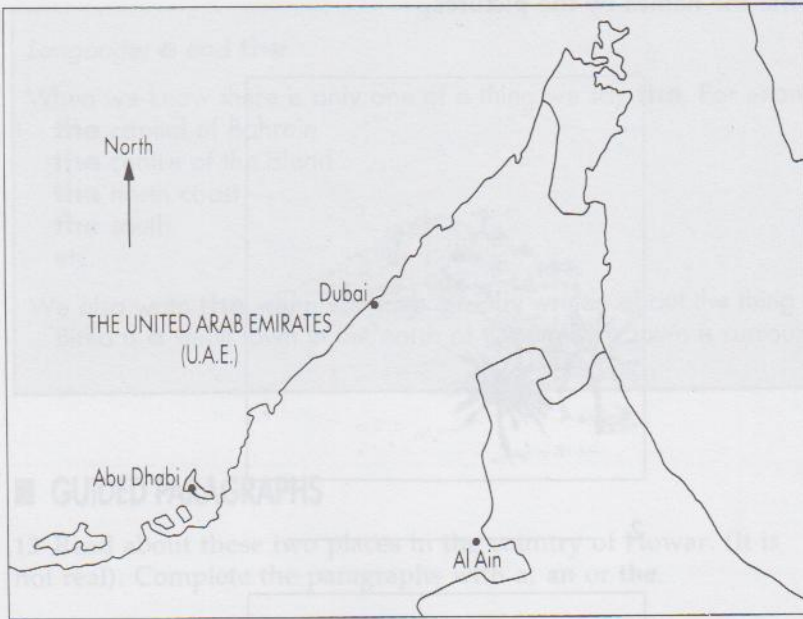

Al Ain \_\_\_\_\_ a \_\_\_\_\_ in the \_\_\_\_\_ of the \_\_\_\_\_  
 \_\_\_\_\_ . It \_\_\_\_\_ population \_\_\_\_\_  
 thousand people. It \_\_\_\_\_ famous for \_\_\_\_\_ and \_\_\_\_\_ .  
 There \_\_\_\_\_ a \_\_\_\_\_ and an \_\_\_\_\_ . Al Ain also  
 \_\_\_\_\_ a very interesting \_\_\_\_\_ and \_\_\_\_\_

**■ PUNCTUATION**

15 Put the capital letters, full stops and commas in these sentences.

- a) my brother lives in the united states of america
- b) athens is the capital city of greece
- c) my sister studies french in a university in tunisia
- d) abdullah was born in jordan but he lives in the united arab emirates
- e) he lives in a town in the north of iraq

16 Read about this city. Write in the capital letters and full stops.  
 One comma is missing.

bombay is a large city in the west of india it has a population of ten million it is situated on the

coast there is a large harbour in bombay and there are many parks gardens and markets

bombay is famous for its harbour and for its film industry

Three verbs are used in this paragraph. What are they?

\_\_\_\_\_, \_\_\_\_\_ and \_\_\_\_\_.

Now complete the table with information about Bombay:

Name:	_____
Town/city/village:	_____
Country:	_____
Situated:	_____
Population:	_____
Famous for:	_____
Interesting places:	_____

**PARAGRAPH WRITING**

17 Write a paragraph about Alexandria. Use the table on the next page and the map below. Use these verbs: **is, are** and **has**.

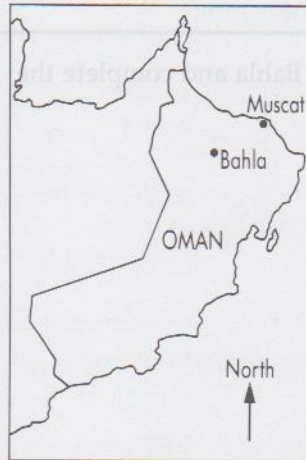
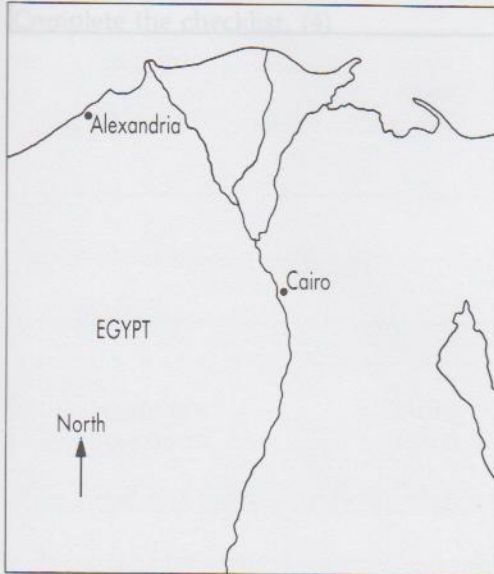

<i>Name:</i>	Alexandria	Bahla
<i>Town/city/village:</i>	city	town
<i>Country:</i>	Egypt	Oman
<i>Situated:</i>	north coast	north
<i>Population:</i>	4,000,000	8,000
<i>Famous for:</i>	harbour and beaches	magic, pottery
<i>Interesting places:</i>	library, Montazah palace, Roman theatre, aquarium.	fort, market, date gardens.

**Checklist**

Read your paragraph again and answer these questions.  
Write your answers under 1.

	Paragraph			
	1	2	3	4
a) How many sentences are there?				
b) How many full stops?				
c) Does every sentence begin with a capital letter?				
d) Do the names of places begin with capital letters?				
e) Does each sentence have a verb?				

18 Now write a paragraph about Bahla and complete the checklist. (2)

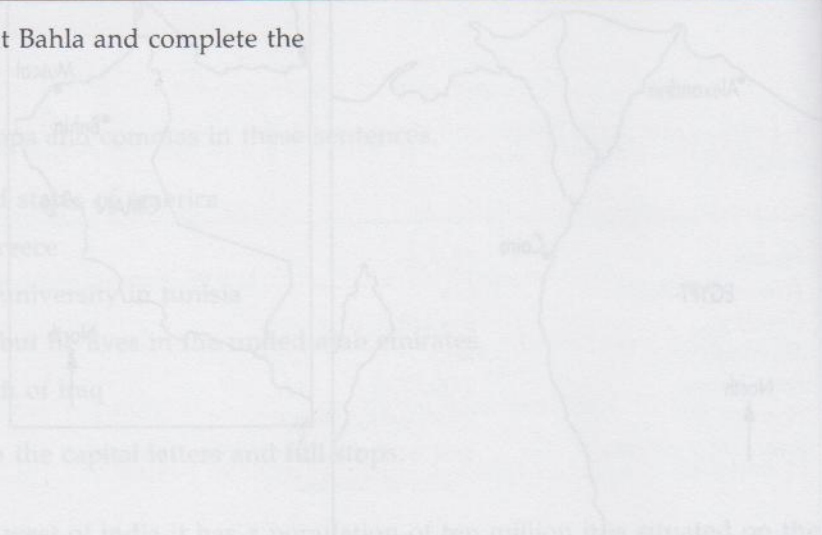

19 Write about your town, village or city or one that you know. First complete part A of the table below. It will help you.

	A	B
Name:	_____	_____
Town/city/village:	_____	_____
Country:	_____	_____
Situated:	_____	_____
Population:	_____	_____
Famous for:	_____	_____
Interesting places:	_____	_____

Complete the checklist. (3)

Now exchange your book with a partner. Make sure your partner has not written about the same place. Complete part B in the table above with information from his/her paragraph.

20 Read the paragraph about Bahrain on page 32 again. Now draw a map of your country and put in the capital city and the main cities and towns. Write a paragraph about the country.

Complete the checklist. (4)

**■ CORRECTING WRITTEN WORK**

21 Read this paragraph about a city. There are the following mistakes:

- FIVE spelling mistakes.
- THREE full stops are missing.
- THREE capital letters are missing.
- ONE comma is missing.

Try to find them and correct them.

London is a lagne city in  
 the soth of england. it is  
 situatd on a river london is  
 famous for its old bildings its  
 parks and gardens lt has a  
 population of aboat eight  
 million people

Now write out the paragraph correctly.

**■ SPELLING AND VOCABULARY**

22 Make the names of countries from the jumbled letters and write them below. They are all in this unit.

nabenol  
 inhabra  
 crege

taraq  
 creanf  
 danii

kureyt  
 instau  
 isausr

pyteg  
 yaris  
 het deutin tasset

naskipat  
 ranodj

\_\_\_\_\_

\_\_\_\_\_

\_\_\_\_\_

These countries do not appear in the unit. What are they?

iwakut  
 danaac

dalnloh  
 neemy

dauns  
 laity

pinas  
 baliy

lesnetipa  
 tinranage

K \_\_\_\_\_ H \_\_\_\_\_ S \_\_\_\_\_ S \_\_\_\_\_ K \_\_\_\_\_

C \_\_\_\_\_ Y \_\_\_\_\_ I \_\_\_\_\_ L \_\_\_\_\_ A \_\_\_\_\_

23 p and b

Say these words to yourself:

pin	bin
pat	bat
pet	bet
peach	beach

Now complete these words with p or b.

- |                  |                                      |
|------------------|--------------------------------------|
| a) _ _ o _ _ l e | b) _ o r n                           |
| c) _ o y         | d) o _ _ o s i t e                   |
| e) _ _ u s       | f) a _ _ l e                         |
| g) _ a _ e r     | h) _ o _ u l a t i o n               |
| i) _ r o t h e r | j) _ l a y i n g _ a s k e t _ a l l |

24 Vowels

These words are all from the unit. Write in the missing vowels (a, e, i, o, and u).

f _ r t	m _ r k _ t	c _ s t l _
f _ c t _ r y	g _ r d _ n	v _ l l _ g _
n _ r t h	c _ n t r _	c _ r n _ c h _
r _ v _ r	w _ s t	c _ p _ t _ l

Take care with spelling when there are two vowels together in a word, for example: harbour

a b _ _ t	m _ _ n t _ _ n
b _ _ t	m u s _ _ m
b _ _ l d i n g	s i t _ _ t e d
c _ _ n t r y	s _ _ t h
f a m _ _ s	s u r r _ _ n d e d
b _ _ c h	p o p u l a t _ _ n

This word has three vowels together! What is it?

b \_ \_ \_ t i f u l